

Table of Contents

1. Introduction	5
1.1. Minimum System Requirements	6
1.2. Box Content	7
1.3. Views of the Drive	8
1.4. Cables and Connectors	10
2. Setting Up Your LaCie 2big	12
2.1. Connect the Interface Cable	13
2.2. Turn the Drive On	14
3. RAID	15
3.1. About RAID Modes.....	15
3.1.1. Fast (RAID 0).....	15
3.1.2. Big (Concatenation)	16
3.1.3. Safe (RAID 1)	17
3.1.4. Mixed (RAID 1 and RAID 0)	17
3.2. Changing the RAID Mode.....	18
3.3. Removing and Installing Drives.....	19
3.4. Formatting.....	20
3.4.1. File System Formats	20
3.4.2. Formatting for Windows Users	22
3.4.3. Formatting for Mac Users	24
3.5. Partitioning the Disks	25
3.5.1. Windows Users.....	25
3.5.2. Mac Users	29
4. Troubleshooting	30
4.1. LED Status Indicators	31
4.2. Other Troubleshooting Topics	33
5. Contacting Customer Support	34
5.1. LaCie Technical Support Contacts	35
6. Warranty Information	36

Copyrights

Copyright © 2011 LaCie. All rights reserved. No part of this publication may be reproduced, stored in a retrieval system, or transmitted in any form or by any means, electronic, mechanical, photocopying, recording or otherwise, without the prior written consent of LaCie.

Trademarks

Apple, Mac, and Macintosh are registered trademarks of Apple Inc. Microsoft, Windows 98, Windows 98 SE, Windows 2000, Windows Millennium Edition, Windows XP and Windows Vista are registered trademarks of Microsoft Corporation. Other trademarks mentioned in this manual are the property of their respective owners.

Changes

The material in this document is for information only and subject to change without notice. While reasonable efforts have been made in the preparation of this document to assure its accuracy, LaCie assumes no liability resulting from errors or omissions in this document, or from the use of the information contained herein. LaCie reserves the right to make changes or revisions in the product design or the product manual without reservation and without obligation to notify any person of such revisions and changes.

Canada Compliance Statement

This Class B digital apparatus meets all requirements of the Canadian Interference-Causing Equipment Regulations.

Japan Compliance Statement

This is a Class B product based on the standard of the Voluntary Control Council for Interference from Information Technology Equipment (VCCI). If this is used near a radio or television receiver in a domestic environment, it may cause radio interference. Install and use the equipment according to the instruction manual.

FCC Statement



This device complies with Part 15 of the FCC Rules. Operation is subject to the following conditions:

1. The devices may not cause harmful interference
2. The devices must accept any interference received, including interference that may cause undesired operation.

NOTE: This equipment has been tested and found to comply with the limits for a Class B digital device, pursuant to Part 15 of the FCC Rules. These limits are designed to provide reasonable protection against harmful interference in a residential installation. This equipment generates, uses and can radiate radio frequency energy and, if not installed and used in accordance with the instructions, may cause harmful interference to radio communications. However, there is no guarantee that interference will not occur in a particular installation. If this equipment does cause harmful interference to radio or television reception, which can be determined by turning the equipment off and on, the user is encouraged to try and correct the interference by one or more of the following measures:

- ◆ Reorient or relocate the receiving antenna.
- ◆ Increase the separation between the equipment and receiver.
- ◆ Connect the equipment into an outlet on a circuit different from that to which the receiver is connected.
- ◆ Consult the dealer or an experienced radio/TV technician for help.

CE Manufacturer's Declaration for CE Certification

We, LaCie, solemnly declare that this product conforms to the following European standards: Class B EN60950, EN55022, EN55024, EN61000-3-2: 2000, EN61000-3-3: 2001

With reference to the following conditions: 2006/95/EC Low Voltage Directive; 2004/108/EC EMC Directive



This symbol on the product or on its packaging indicates that this product must not be disposed of with your other household waste. Instead, it is your responsibility to dispose of your waste equipment by handing it over to a designed collection point for the recycling of waste electrical and electronic equipment. The separate collection and recycling of your waste equipment at the time of disposal will help to conserve natural resources and ensure that it is recycled in a manner that protects human health and the environment. For more information about where you can drop off your waste equipment for recycling, please contact your local city office, your household waste disposal service, or the shop where you purchased the product.

CAUTION: Modifications not authorized by the manufacturer may void the user's authority to operate this device.

CAUTION: A shielded-type power cord is required in order to meet FCC emission limits and also to prevent interference to the nearby radio and television reception. It is essential that only the supplied power cord be used.

Health and Safety Precautions

- ◆ Only qualified persons are authorized to carry out maintenance on this device.
- ◆ Read this User Manual carefully and follow the correct procedure when setting up the device.
- ◆ Do not open a disk drive or attempt to disassemble or modify it. Never insert any metallic object into the drive to avoid any risk of electrical shock, fire, short-circuiting or dangerous emissions. The disk drives shipped with your LaCie 2big contain no user-serviceable parts. If it appears to be malfunctioning, have it inspected by a qualified LaCie Technical Support representative.
- ◆ Never expose your device to rain, or use it near water, or in damp or wet conditions. Never place objects containing liquids on the LaCie 2big, as they may spill into its openings. Doing so increases the risk of electrical shock, short-circuiting, fire or personal injury.

General Use Precautions

- ◆ Power requirements 100-240 V~, 1.5 A, 50-60 Hz, (supply voltage fluctuations not exceeding $\pm 10\%$ of the nominal and transient over-voltages according to over-voltage category II).
- ◆ Do not expose the LaCie 2big to temperatures outside the range of 5° C to 35° C (41° F to 95° F); or to operational humidity beyond 5-80%, non-condensing, or non-operating humidity beyond 10-90%, non-condensing. Doing so may damage the LaCie 2big or disfigure its casing. Avoid placing your LaCie 2big near a source of heat or exposing it to sunlight (even through a window). Inversely, placing your LaCie 2big in an environment that is too cold may damage the unit.
- ◆ Rated cooling for altitudes up to 2000 meters.
- ◆ Always unplug the LaCie 2big from the electrical outlet if there is a risk of lightning or if it will be unused for an extended period of time. Otherwise, there is an increased risk of electrical shock, short-circuiting or fire.
- ◆ Use only the power supply shipped with the device.
- ◆ Do not use the LaCie 2big near other electrical appliances such as televisions, radios or speakers. Doing so may cause interference which will adversely affect the operation of the other products.
- ◆ Do not place the LaCie 2big near sources of magnetic interference, such as computer displays, televisions or speakers.
- ◆ Magnetic interference can affect the operation and stability of your LaCie 2big.
- ◆ Never use excessive force on your LaCie 2big. If you detect a problem, consult the Troubleshooting section in this manual.
- ◆ Protect your LaCie 2big from excessive exposure to dust during use or storage. Dust can build up inside the device, increasing the risk of damage or malfunction.
- ◆ Never use benzene, paint thinners, detergent or other chemical products to clean the outside of the LaCie 2big. Such products will disfigure and discolor the casing. Instead, use a soft, dry cloth to wipe the device.
- ◆ Please replace defective hard drives only with a new drive provided by LaCie. For drive removal process, see section [3.3. Removing and Installing Drives](#).
- ◆ If ambient temperatures exceed Over 30° C (86° F), LaCie recommends not stacking or racking more than two 2big Disks on top of each other, especially if these drives are turned on simultaneously.



IMPORTANT INFO: Any loss, corruption or destruction of data while using a LaCie drive is the sole responsibility of the user, and under no circumstances will LaCie be held liable for the recovery or restoration of this data. To help prevent the loss of your data, LaCie highly recommends that you keep **TWO** copies of your data; one copy on your external hard disk, for instance, and a second copy either on your internal hard disk, another external hard disk or some other form of removable storage media. LaCie offers a complete line of CD and DVD drives. If you would like more information on backup, please refer to our website.



IMPORTANT INFO: 1GB = 1,000,000,000 bytes. 1TB = 1,000,000,000,000 bytes. Once formatted, the actual available storage capacity varies depending on operating environment (typically 5-10% less).

1. Introduction

Congratulations on the purchase of your new LaCie 2big Quadra. This high-performance, extremely flexible RAID (Redundant Array of Independent/Inexpensive Disks) subsystem is ideally suited for integration with databases, imaging systems and e-mail and Web servers.

RAID technology is one of the best means to protect your data, while providing greater data integrity and availability than standard hard disk storage. With the ability to provide single error detection and redundant information to recover the original if a disk fails, a RAID system is an ideal means to safe-guard valuable data while also stream-lining performance.

The LaCie 2big is the ultimate approach to a flexible RAID solution, with its ability to manage various RAID levels for a wide range of applications.

Features

- ◆ eSATA 3Gbits, FireWire 800, FireWire 400 & Hi-Speed USB 2.0
- ◆ 4 RAID modes: RAID 0, RAID 1, Mixed or Concatenation
- ◆ Daisy-chainable via FireWire
- ◆ 2 removable SATA drives with locks
- ◆ Plug & play
- ◆ Quiet thermoregulated smart fan
- ◆ Triple Power Management ("Auto" for energy efficiency; "On" for instant access; "Off" for data protection)

Quick Links

Click a topic:

- ◆ **Connecting** the Interface Cable
- ◆ **Turning** the Drive On
- ◆ **Changing** the RAID Mode



1.1. Minimum System Requirements



Windows Users

- ◆ Windows 2000*, Windows XP*, or Windows Vista
- ◆ 500MHz Pentium III or higher (or equivalent processor)
- ◆ 512MB RAM or greater
- ◆ Available USB 2.0, FireWire 400, FireWire 800 or eSATA interface port**



Mac Users

- ◆ Mac OS X 10.3 or later
- ◆ G4, G5, Intel Core Duo or Intel Core 2 Duo
- ◆ 512MB RAM or greater
- ◆ Available USB 2.0, FireWire 400, FireWire 800 or eSATA interface port**

*Windows 2000 and Windows XP will not recognize logical volumes with capacity greater than 2TB. For details, see section [3.4.1. File System Formats](#).

**Most computers do not come from the factory with FireWire 800 or eSATA ports, so you may need to purchase a PCI, PCI-X or PCI-Express card to be able to connect your LaCie 2big via FireWire 800 or eSATA interface. LaCie offers a wide selection of PCI cards. Visit the LaCie website at www.lacie.com/accessories.

1.2. Box Content

Your LaCie 2big package contains the system tower and an accessories box containing the items listed below.

1. LaCie 2big Quadra
2. Hi-Speed USB 2.0 cable
3. FireWire 400 (6-to-6 pin) cable
4. FireWire 800 (9-to-9 pin) cable
5. eSATA-to-eSATA (3Gbits) cable
6. Power supply kit
7. LaCie Utilities CD-ROM
8. Quick Install Guide
9. 2-in-1 RAID mode change and drive removal tool



IMPORTANT INFO: Please save your packaging. In the event that the drive should need to be repaired or serviced, it must be returned in its original packaging.

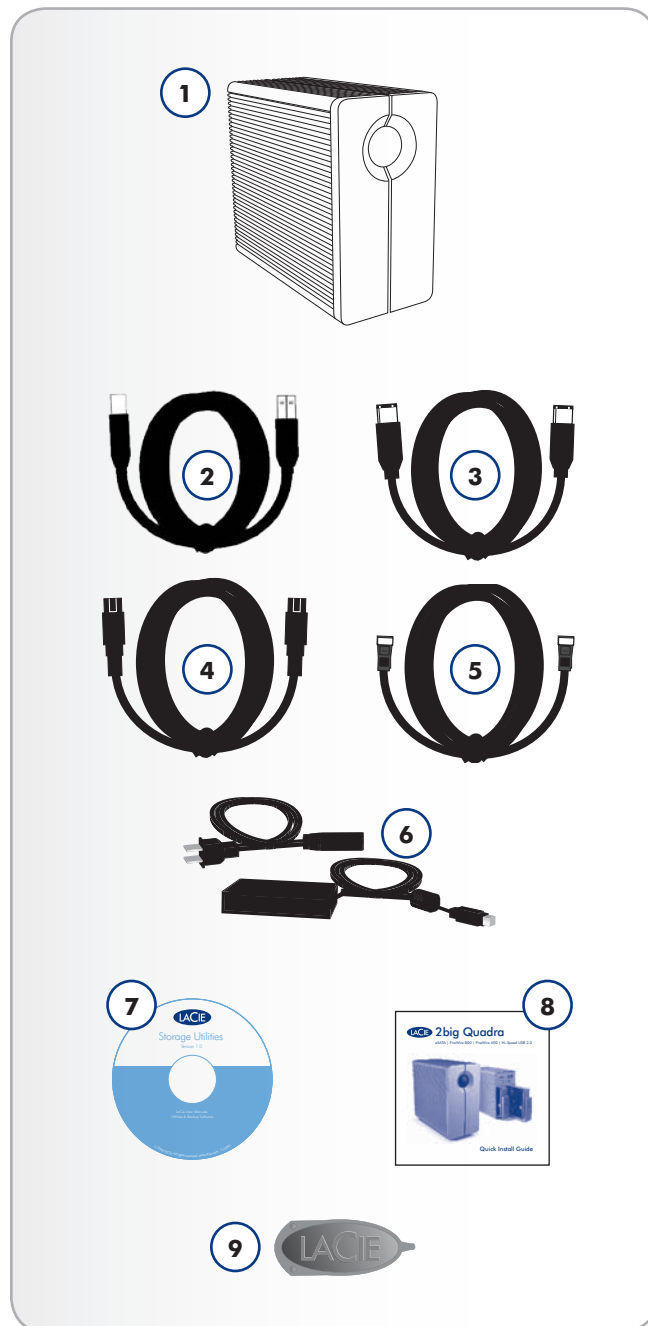

1.3. Views of the Drive

Front View

The blue button (A) on the front of the LaCie 2big serves as an LED drive status indicator and the LaCie Shortcut Button.

See the LaCie Shortcut Button User Manual on the Shortcut Button CD-ROM for more information.

See troubleshooting section [4.1. LED Status Indicators](#) for more information.

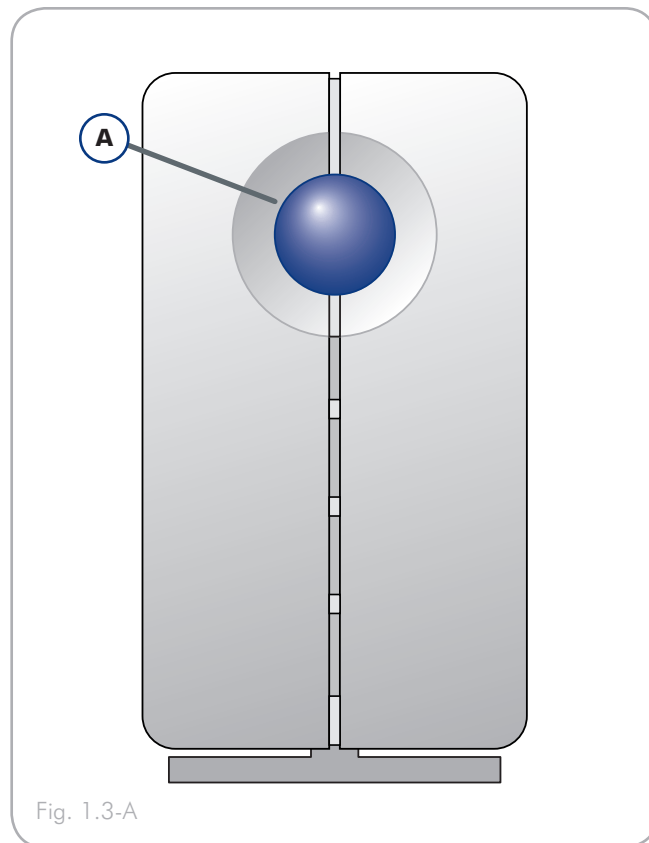

Fig. 1.3-A

Rear View

1. RAID switch
2. off/auto/on power switch
3. eSATA 3Gbits port
4. USB 2.0 port
5. FireWire 800 ports
6. FireWire 400 port
7. Power input connection
8. Drive tray handle
9. Drive lock
10. Drive status LED
11. RAID mode LEDs



CAUTION: To avoid overheating, the LaCie 2big should be installed in a well-ventilated area and in such a way as to maintain sufficient airflow across the controller chips. Also ensure that the Ventilation Fan is not obstructed.

Please use the included stand and rubber feet which elevate the 2Big and allow for better heat dissipation.

Environmental Requirements:

Temperature: 0 – 35° C (32 – 95° F)

Operation Humidity: 20 – 80%, non-condensing

Storage Humidity: 10 – 90%, non-condensing

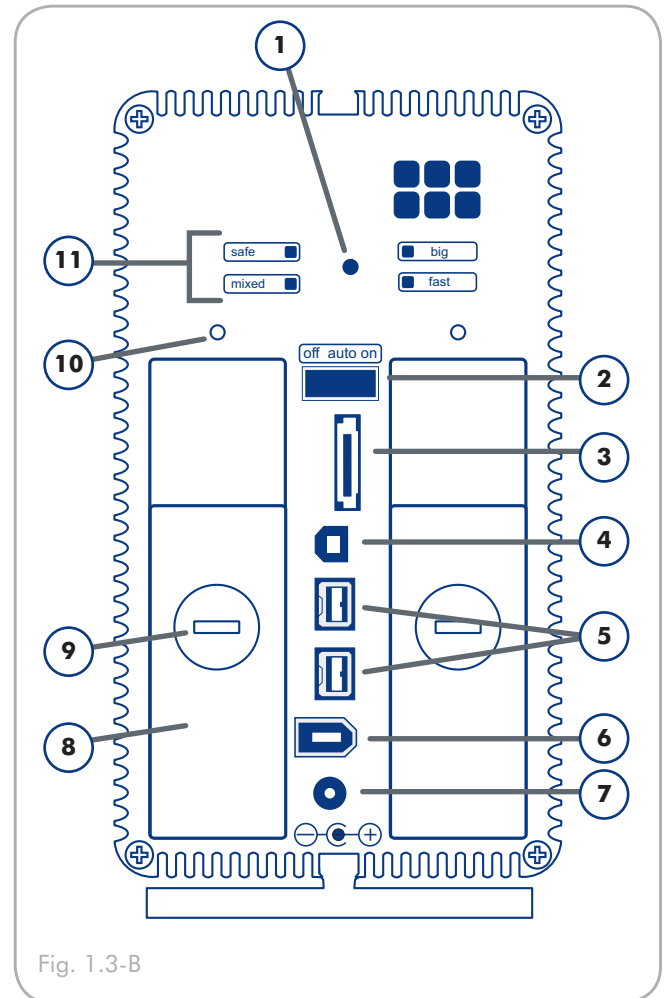

Fig. 1.3-B

1.4. Cables and Connectors

USB 2.0

USB is a serial input/output technology for connecting peripheral devices to a computer or to each other. Hi-Speed USB 2.0 is the latest implementation of this standard, and it provides the necessary bandwidth and data transfer rates to support high speed devices such as hard drives, CD/DVD drives and digital cameras.

Included USB Cable

Your LaCie drive is shipped with a Hi-Speed USB 2.0 cable, to ensure maximum data transfer performance when connected to a Hi-Speed USB 2.0 port. The cable will also work when connected to a USB port, but drive performance will be limited to USB 1.1 transfer rates.

Hi-Speed USB 2.0 Benefits

- ◆ Backwards compatibility: Hi-Speed USB 2.0 works with the original USB specifications.
- ◆ Hot-pluggable: no need to shut down or restart your computer when adding or removing devices.



USB Cable Ends

FireWire

FireWire 400, also known as IEEE 1394, is a high-speed serial input/output technology for connecting peripheral devices to a computer or to each other, and FireWire 800 is the implementation of the new IEEE 1394b standard.

FireWire 800 offers increased bandwidth and extended cabling distance between devices. FireWire 800 is ideal for bandwidth-intensive applications, such as audio, video and graphics.

Included FireWire Cables

Your LaCie hard disk is shipped with a FireWire 400 cable and a FireWire 800 cable.

FireWire Benefits

- ◆ Hot-pluggable: devices can be added and removed while the bus is active.
- ◆ Isochronous data delivery: no dropped frames – FireWire supports real-time data delivery.
- ◆ Flexible: up to 63 devices can be connected on a single bus.



FireWire 400 Cable Ends



FireWire 800 Cable Ends

eSATA

Your LaCie 2big uses the latest in SATA technology, allowing interface (or bus) transfer rates of up to 3 Gbits/s. SATA technology was originally developed to serve as an internal interface, delivering improved performance to internal connections. Soon after, eSATA, or external SATA was developed, allowing for the use of shielded cables outside the PC.

eSATA technology was developed to be rugged and durable. eSATA connectors do not have the “L” shaped design of other SATA connectors. In addition, the guide features are vertically offset and reduced in size to prevent the use of unshielded internal cables in external applications.

Included eSATA Cable

Your LaCie drive is shipped with a eSATA cable, to ensure maximum data transfer performance when connected to a eSATA port.

eSATA Benefits

- ◆ eSATA interface can achieve up to 3 Gbits/s theoretical transfer rate.
- ◆ Plug orientation – An extrusion on the outside of the connector helps guide and align the connector during insertion.
- ◆ Hot-plug support – eSATA enables adding and removing a drive without having to power down the system or reboot.



eSATA Cable Ends

2. Setting Up Your LaCie 2big

This section covers the installation and configuration of your LaCie 2big. Follow the steps below to power on and configure your 2big:

Step 1: [2.1. Connect the Interface Cable](#)

Step 2: [2.2. Turn the Drive On](#)

Step 3: [3.4. Formatting](#) – Format the drives to suit your storage needs. For more information about file system formats, see section [3.4.1. File System Formats](#).

2.1. Connect the Interface Cable

1. Plug one end of the interface cable (USB, FireWire or eS-ATA) into the corresponding port on your host computer.
2. Connect the other end of the cable to the matching port on the 2big.



TECHNICAL NOTE: If two interfaces are connected at the same time, the first one connected remains active and the second will not work.

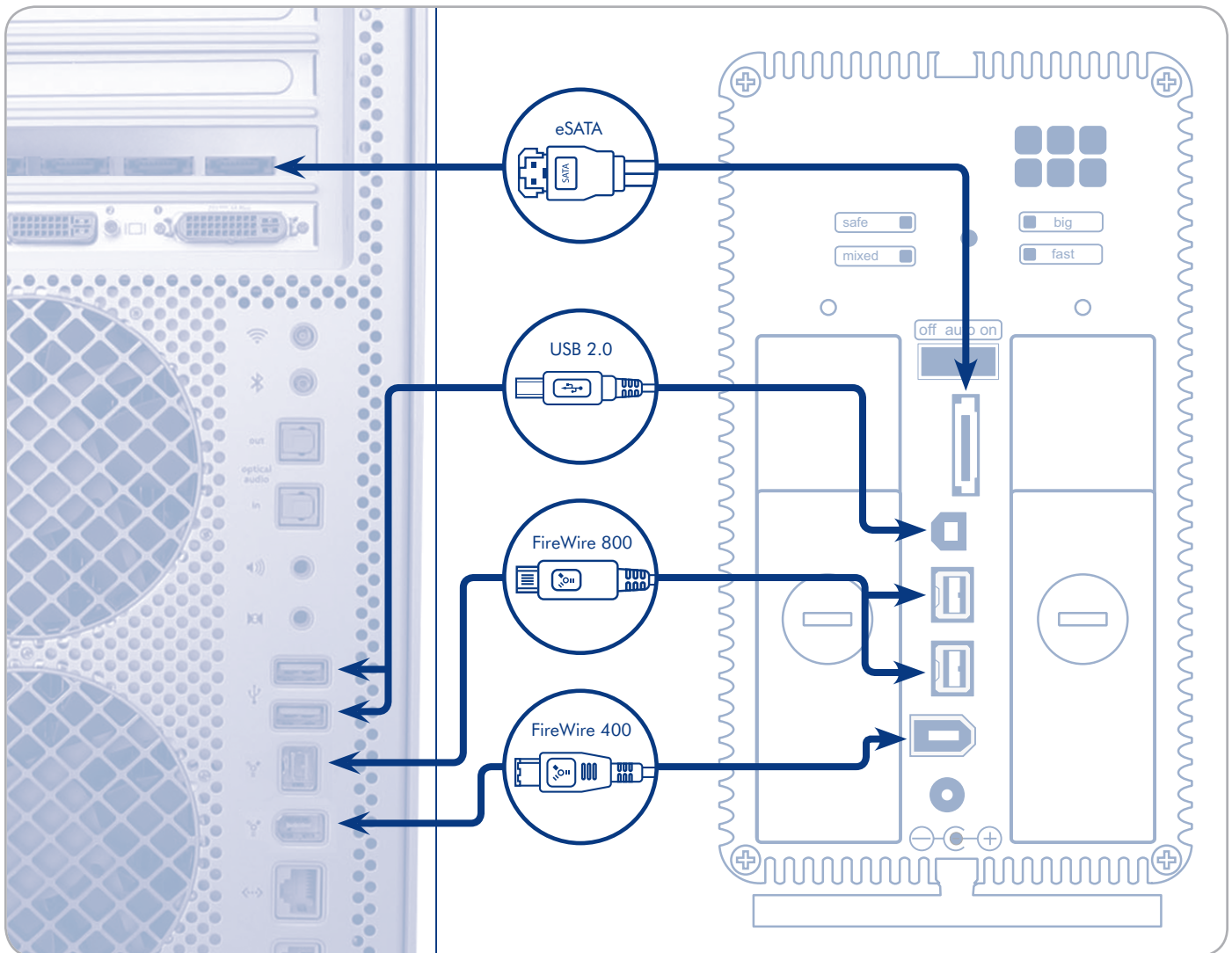

2.2. Turn the Drive On

The power supply kit is composed of two cables: one cable (A) connects to the LaCie drive; and the other cable (B) connects to a power outlet, such as a wall outlet or a surge protector.

1. Connect Cable **A** to the 2big.
2. Connect Cable **B** to the power supply brick (**C**).
3. Connect Cable **B** to a surge protector or wall outlet.
4. Turn on the drive by moving the power switch on the back of the drive to the “on” position.

The 2big system may take up to 30 seconds to boot up

CAUTION: Only use the AC adapter supplied with your specific LaCie device. Do not use a power supply from another LaCie device or another manufacturer. Using any other power cable or power supply may cause damage to the device and void your warranty.

Always remove the AC adapter before transporting your LaCie drive. Failure to remove the adapter may result in damage to your drive and will void your warranty.

TECHNICAL NOTE: You may use your LaCie drive when in a foreign country thanks to its 100-240 Volt power supply. To be able to use this feature, you may need to purchase an appropriate adapter or cord. LaCie accepts no responsibility for any damage to the drive resulting from the use of an inappropriate adapter. Using an adapter other than one authorized by LaCie will void your warranty.

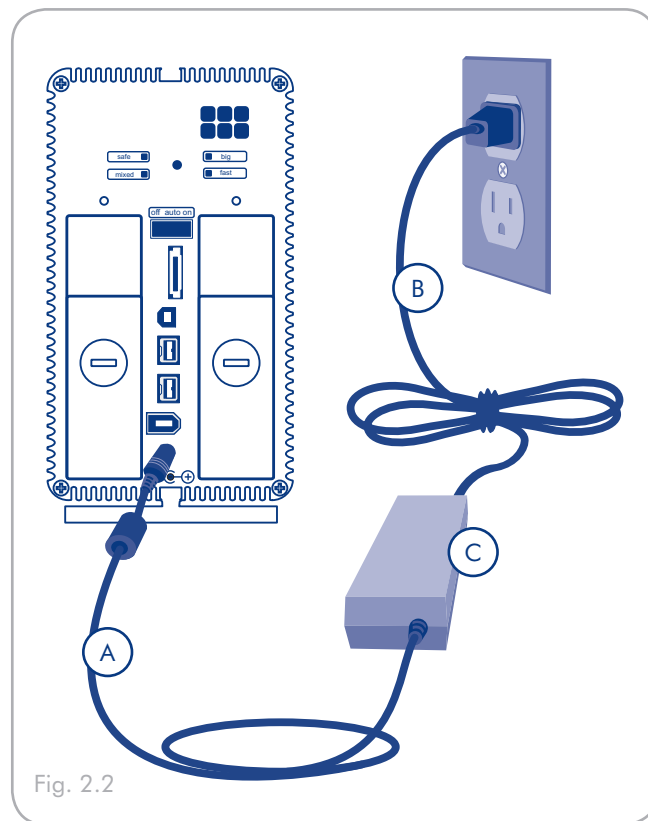

Fig. 2.2

NOTE: Depending on your country, power outlet connections may be different from the one shown above.

3. RAID

3.1. About RAID Modes

This section will help you decide which RAID mode is right for your application.

RAID Mode	Capacity	Protection	Speed
Fast (RAID 0)	100%	★ ★ ★ ★ ★	★ ★ ★ ★ ★
Big (Concatenation)	100%	★ ★ ★ ★ ★	★ ★ ★ ★ ★
Safe (RAID 1)	50%	★ ★ ★ ★ ★	★ ★ ★ ★ ★
Mixed (RAID 0 and RAID 1)	75%	★ ★ ★ ★ ★	★ ★ ★ ★ ★

3.1.1. Fast (RAID 0)

The 2big Quadra is pre-configured in RAID 0, the fastest RAID mode. Requiring at least 2 drives, RAID 0 stripes data onto each disk. The available capacities of each disk are added together so that one logical volume mounts on the computer.

If one physical disk in the array fails, the data of all disks becomes inaccessible because parts of the data have been written to all disks.

Applications

RAID 0 is ideal for users who need maximum speed and capacity. Video editors working with very large files may use RAID 0 when editing multiple streams of video for optimal playback performance. While a RAID 0 array is suited for actively working with files (editing video, for example), users interested in a higher level of security should use RAID 1.

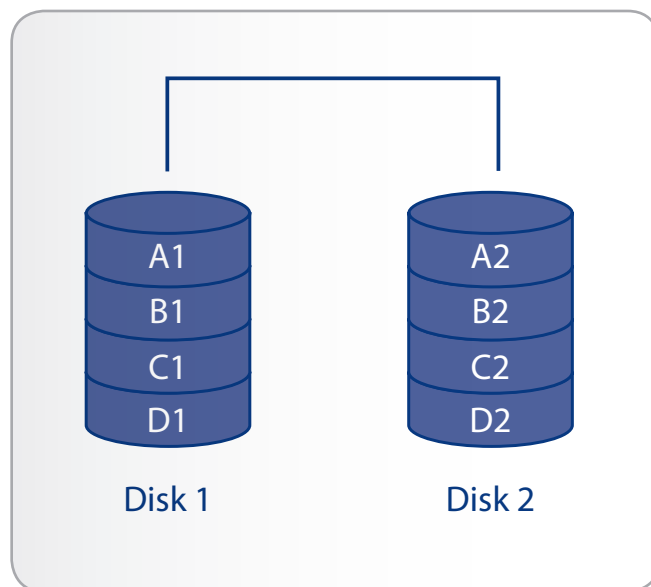

3.1.2. Big (Concatenation)

When disks are concatenated, their capacities are combined and data is written to the primary disk in the array until it is full, and then to successive disks. Concatenation provides no performance advantage or added measure of data safety. It is simply a method of combining more than one physical disk into one volume for greater overall capacity.

Concatenation allows full use of the capacity of all disks in the array, but users interested in a higher level of protection should use RAID1.

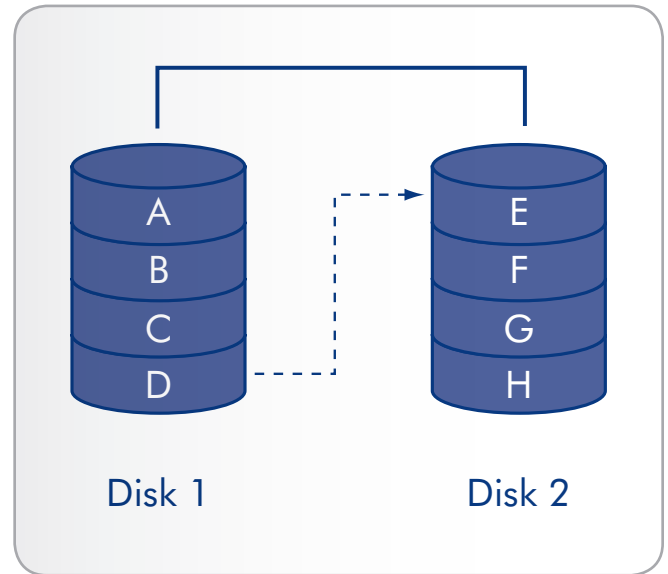

3.1.3. Safe (RAID 1)

In Safe mode (RAID 1), the two physical disks are mirrored together so that one single logical volume mounts on the desktop.

All data is saved simultaneously on each disk (the available capacity cannot exceed the available capacity of the lowest-capacity single disk). If one physical disk fails, the data is available immediately on the second disk. No data is lost if one disk fails.

Applications

- ◆ Maximum data safety
- ◆ Safe reduces the total available capacity by 50% because two copies of the data are saved.

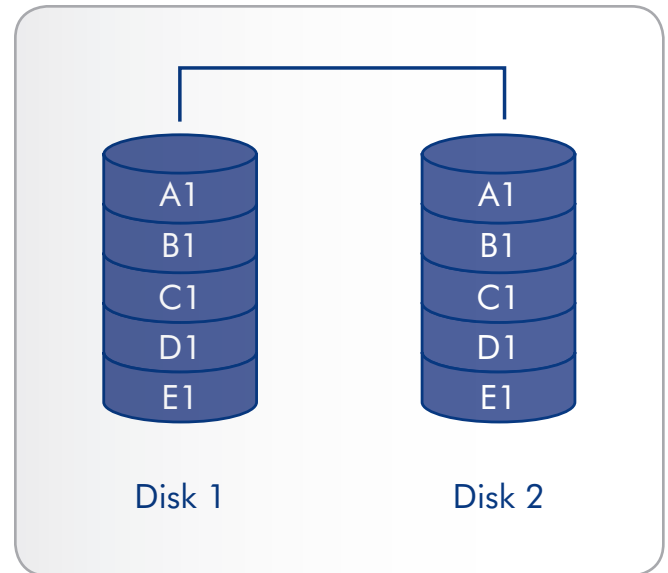

3.1.4. Mixed (RAID 1 and RAID 0)

In Mixed mode, the two physical disks are combined so that two logical volumes mount simultaneously on the desktop:

- ◆ One Safe volume (RAID 1) where data is automatically mirrored on each physical disk. This volume uses 50% of the available capacity of each disk (the available capacity cannot exceed 50% of the lowest-capacity single disk).



IMPORTANT INFO: If one physical disk fails, the data of the SAFE volume is available on the second disk. Only 25% of full capacity is protected by mirroring. In this case, data on the Fast (RAID 0) volume will be lost.

- ◆ One Fast volume (RAID 0) enables the user to work with the high speed of RAID 0.

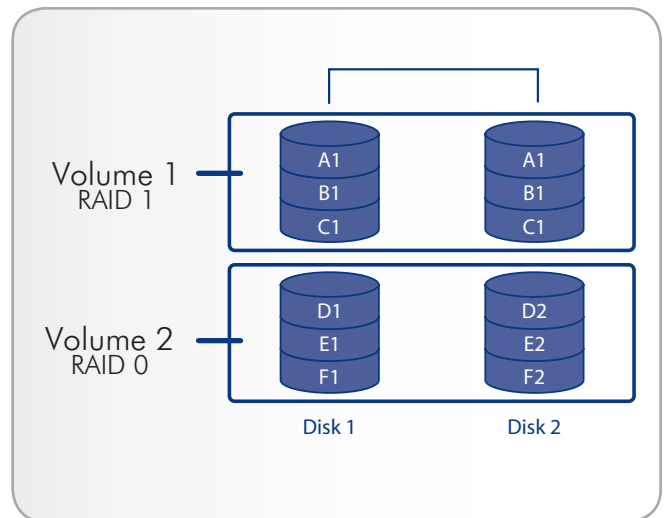

Applications

- ◆ Provides two volumes for different data security needs.
- ◆ Only 75% of total formatted capacity is available due to mirroring on the Safe volume.

3.2. Changing the RAID Mode

Before you change the RAID mode of the LaCie 2big, familiarize yourself with the 2big's RAID modes. See section [3.1. About RAID Modes](#).



IMPORTANT INFO: Changing the RAID mode destroys data stored on the LaCie 2big. If you have saved data on the drives, back up data to another medium before following these steps.



CAUTION: Disk drives must be inserted correctly in the 2big before configuration can be changed.

To change the RAID mode:

1. Unmount or safely remove the 2big Quadra volumes from your computer, disconnect the interface cable, and switch off the 2big.
2. To enter RAID modification mode, push and hold the front button and simultaneously turn on the 2big. Continue holding the front button for 2 seconds.
3. Use the 2-in-1 tool to push the RAID selection button until the light arrives in front the desired RAID mode. The LED of the selected mode will blink until you validate it (next step).
4. Validate the mode by pushing and holding the front LED button for 2 seconds.
5. Turn off the 2big, allow it to shut down and turn it back on.
6. Reformat the disks. See section [3.5. Partitioning the Disks](#).



IMPORTANT INFO: You must partition the disk drives after changing the RAID mode. See section [3.5. Partitioning the Disks](#).



CAUTION: Your LaCie 2big comes preconfigured in Fast (RAID 0) mode. Fast mode allows access to the whole storage capacity but does not provide any security. If a drive fails, all data will be lost. If you are concerned about data security, LaCie highly recommends a RAID 1 (Safe) configuration. See section [3.1. About RAID Modes](#), for more information.

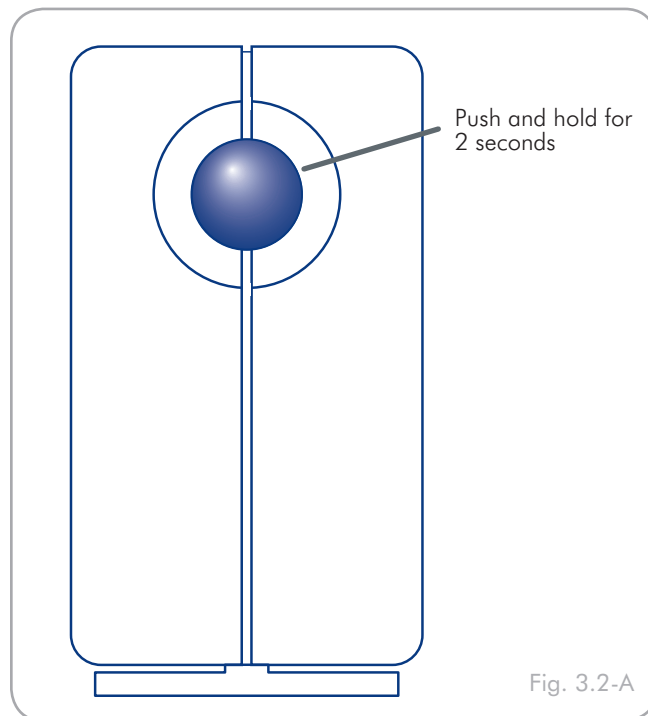

Fig. 3.2-A

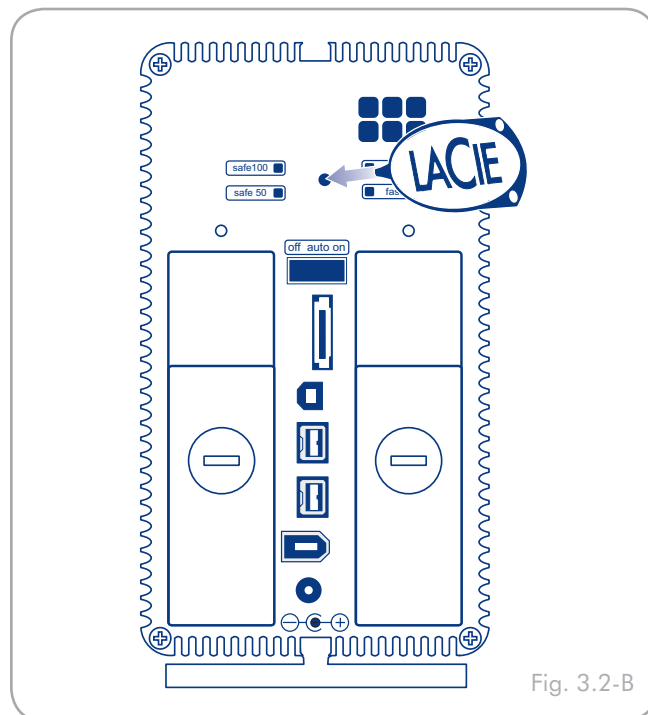

Fig. 3.2-B

3.3. Removing and Installing Drives

In the event that an individual hard disk fails in the LaCie 2big, please contact your LaCie reseller or LaCie Customer Support. Please replace a defective hard drive only with a new drive provided by LaCie. For drive removal and replacement process, please follow the steps below.



CAUTION: After continuous use of the LaCie 2big, drives may be hot. Use caution when removing.



IMPORTANT NOTE: A replacement drive must have the same or greater capacity than the drive it is replacing.

To Remove a Drive:

1. If the 2big is in Fast (RAID 0) or Big (concatenation) mode, turn it off and unplug it. If the 2big is in Safe (RAID 1) or Mixed mode, you can leave it turned on and continue to step 2.
2. The drive tray may be locked. To unlock it, insert the round end of the provided 2-in-1 tool into the slot on the drive lock and turn the lock until the slot is vertical (Fig. 3.3-A).
3. Draw out the drive tray by inserting your finger into the space behind the drive tray handle and pulling to disengage the drive (Fig. 3.3-B).
4. Grasp the drive tray handle and carefully extract the drive (Fig. 3.3-C).
5. Turn the drive on to continue using the remaining drive.

To Install a Drive:

1. If the 2big is in Fast (RAID 0) or Big (concatenation) mode, turn it off and unplug it. If the 2big is in Safe or Mixed mode, you can leave it turned on and continue to step 2.
2. Carefully insert the drive tray into an empty drive bay. When the drive tray is most of the way in and you feel resistance, press the drive tray handle firmly until you feel the drive snap into place and the drive tray handle is flush with the back of the 2big.
3. Use the 2-in-1 tool to lock the drive lock. Turn the locks until the grooves are oriented vertically. The drives are locked when **both** locks are vertical.



TECHNICAL NOTE: Data is still accessible during a Safe (RAID 1) rebuild. The 2big can be disconnected from the workstation during the rebuild; only the power must be connected.



IMPORTANT INFO: Drive warranty will be void if you replace the defective drive with a drive not provided by LaCie. Drives purchased from LaCie are shipped pre-installed in drive trays with handles.



IMPORTANT INFO: In Safe (RAID 1) and Mixed (RAID 1 and RAID 0) mode, in order for rebuilding to occur, the product must be turned on while a replacement disk is installed. LaCie does not recommend removing a drive from a Mixed array unless the drive has failed, as the data on the RAID 0 volume could be lost.



IMPORTANT INFO:

Rebuilding a Safe (RAID 1) array can take several hours. For example, rebuilding a 500GB RAID 1 array can take up to 3 hours.

LaCie does not recommend removing any drives during rebuild.

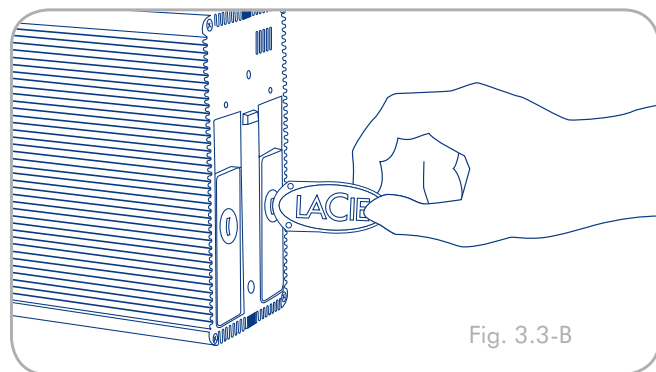

Fig. 3.3-B

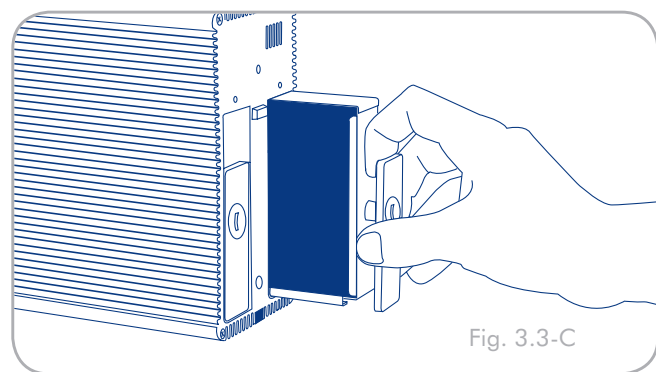

Fig. 3.3-C

3.4. Formatting

The 2big Quadra comes pre-formatted in HFS+ (optimized for Mac OS X). Please read the following information on file system formats for Windows and Mac operating systems to determine if you need to reformat the 2big's disks. See sections [3.4.2](#) and [3.4.3](#) for formatting instructions.

3.4.1. File System Formats

Windows Users

The 2big Quadra comes pre-formatted in HFS+ (optimized for Mac OS X).



TECHNICAL NOTE: Windows XP 32-bit and Windows 2000 do not support volumes greater than 2TB. Windows XP x64, Windows Server 2003 SP1, and Windows Vista Enterprise/Ultimate (32- and 64-bit versions) do, but in order to create volumes bigger than 2TB from these operating systems, you must convert the disk to GPT file system. This process is outlined in [3.4.2. Formatting for Windows Users](#).

FAT 32

FAT is an acronym for File Allocation Table, which dates back to the beginnings of DOS programming. Originally, FAT was only 16 bits, but after the second release of Windows 95 it was upgraded to 32 bits, hence the name FAT 32. In theory, FAT 32 volume sizes can range from less than 1MB all the way to 2TB. It is the native file system of Windows 98 and Windows Me, and is supported by Windows 2000, Windows XP and Windows Vista. When FAT 32 is used with Windows 2000, Windows XP and Windows Vista though, volume size is limited to 32GB (by the Windows partition utility, i.e. Disk Manager), and the individual file size is limited to 4GB.

NTFS

This acronym stands for New Technology Filing System, and it is the native file system for Windows NT, Windows 2000, Windows XP and Windows Vista. NTFS offers several features that are not available with FAT 32; i.e. file compression, encryption, permissions, and auditing, as well as the ability to mirror drives and RAID 5 capabilities. The minimum supported volume size for NTFS is 10MB, with a maximum of 2TB when initialized in MBR format or without a limit when initialized in GPT format, with no limit to file size. Volumes created in NTFS can only be directly accessed (not through shares) by Windows NT, Windows 2000,

File System Formats

There are two different file system formats compatible with Windows operating systems – NTFS and FAT 32 (MS-DOS). Use the information below to determine which format is best for you.

Use NTFS if...

...you will be using the drive only with Windows 2000, Windows XP or Windows Vista (performance will generally be greater when compared to FAT 32). This file system is compatible in read only mode with Mac OS X 10.3 and higher. See technical note at left for information on the 2TB volume size limitation under Windows XP 32-bit and Windows 2000.

Use FAT 32 (MS-DOS) if...

...you will be using your drive with both Windows and Mac OS X 10.3 or sharing the drive between Windows 2000 and Windows XP or Windows Vista. Maximum single file size is 4GB.

Windows XP and Windows Vista without resorting to help from third-party products.

The **LaCie 2big Quadra** comes preformatted in HFS+ for optimum performance with Mac OS X.

Mac OS X Users:

You may customize the drive by reformatting and/or partitioning the drive with separate file system formats. For optimal performance in Mac OS environments, format and partition the drive as one large Mac OS Extended volume.

Mac OS Extended (HFS+)

Mac OS Extended refers to the file system used by Mac OS X. HFS+ represents an optimization of the older HFS file system by using hard disk space more efficiently. With HFS+, you are no longer limited by block size.

MS-DOS File System (FAT 32)

This is the Microsoft file system, more typically known as FAT 32. This is the file system to use if you are going to be using your LaCie Hard Drive between Macs and Windows operating systems.

3.4.2. Formatting for Windows Users

The process of formatting a drive on a computer running Windows 2000, Windows XP or Windows Vista consists of two steps: (1) installing a signature on the drive, and (2) formatting the drive. These steps will erase anything that is on the disk.



CAUTION: Following these steps will erase everything from the 2big. If you have information that you want to protect or continue to use, back up this information onto another medium before performing these steps.



TECHNICAL NOTE:

Windows XP 32-bit and Windows 2000: These operating systems will not recognize volumes greater than 2TB in size.

Windows XP x64 and Windows Vista Enterprise/Ultimate (32- and 64-bit versions): These operating systems will recognize volumes greater than 2TB in size, but the disks must be converted to the GPT file system before partitions greater than 2TB can be created.

1. Connect the drive to the computer via the interface port.
2. Right-click **My Computer** and select **Manage**.
3. From the “Computer Management” window, select **Disk Management** (located below the **Storage** group). See Fig. 3.4.2-A (screens may differ slightly depending on the system).



TECHNICAL NOTE: If the 2big Quadra is in Mixed mode, there will be two partitions on the disk.

4. If the “Initialize and Convert Disk Wizard” window appears, click **Cancel**.
5. Windows will list the Hard Disks that are installed on the system. Locate the drive that is represented by the  icon. Right-click the icon and select **Initialize**.



TECHNICAL NOTE: If the 2big is in Mixed mode, format each partition separately.

6. **Windows XP x64 and Windows Vista Enterprise/Ultimate users only:** Right-click the disk and click **Convert to GPT**.
7. In the box to the right that says **Unallocated**, right-click and select **New Partition...**

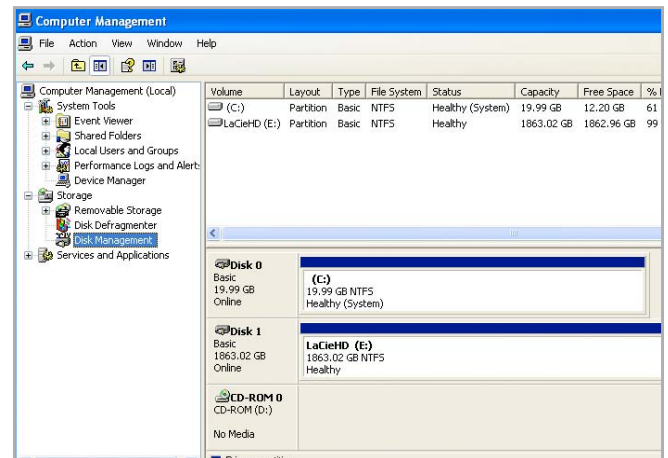

Figure 3.4.2-A

- On the first page of the “New Partition Wizard,” click **Next**. See Fig. 3.4.2-B (screens may differ slightly depending on the system).

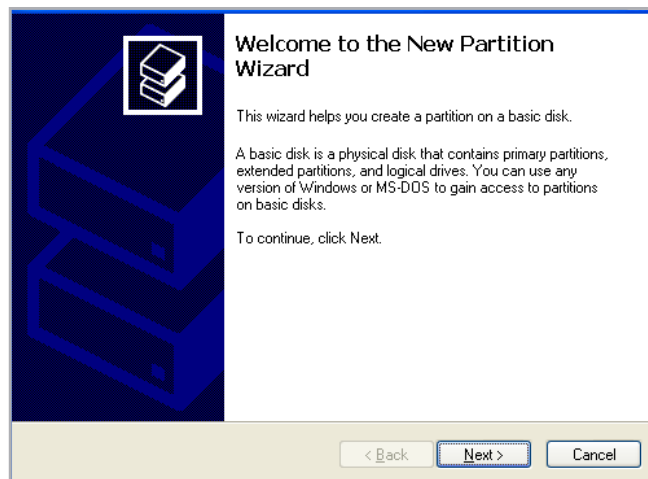

Figure 3.4.2-B

- Click **Next**.
- Click **Next**.
- Click **Next**.
- Click **Next**.
- On the Format Partition window, select **Quick Format**. Click **Next**.



TECHNICAL NOTE: If the 2big is in Mixed mode, format each partition separately.

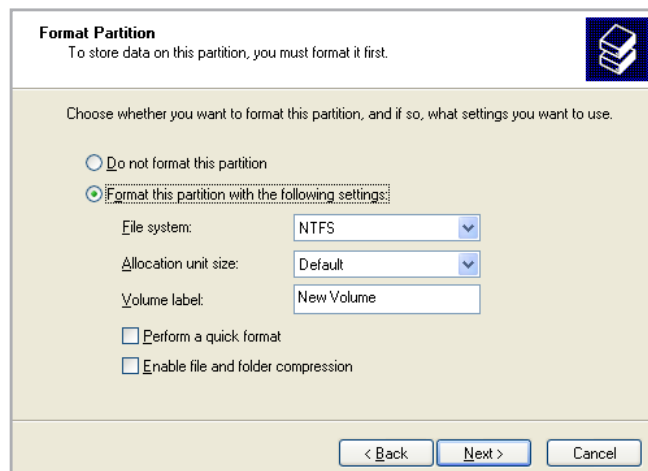

Figure 3.4.2-C

- Click **Finish** to begin the formatting process.
- Windows Disk Management will format and partition the disk according to your settings (Fig. 3.4.2.D.), and your drive will appear in **My Computer**, ready to use.



IMPORTANT INFO: Please refer to section 3.4.1. *File System Formats*, for a more detailed comparison of the various file system formats.

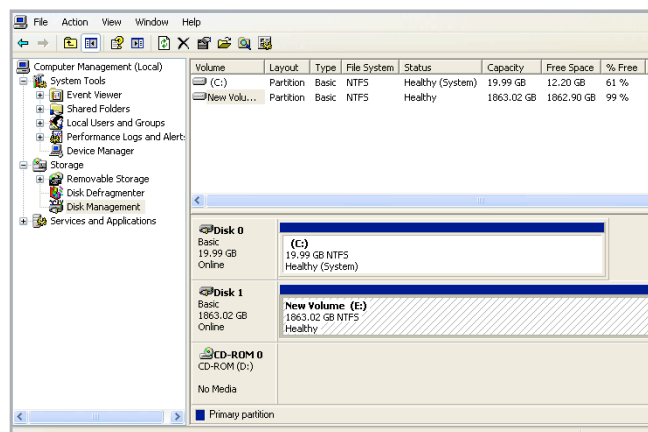

Figure 3.4.2-D

3.4.3. Formatting for Mac Users

1. Connect the drive to the computer and turn on the drive.
2. Select **Utilities** from the **Go** menu in the Finder menu bar.
3. In the Utilities folder, double-click **Disk Utility**.
4. The Disk Utility window will open. Select the volume labeled **LaCie Hard Disk** from the list of available hard disks on the left side of the window.



TECHNICAL NOTE: If the 2big is in Mixed mode, you must initialize each partition separately.

5. Select the **Partition** tab.
6. From the **Volume Scheme:** menu, choose the number of partitions you want to divide the drive into (Mac OS X gives you the option of dividing the drive into at most 16 partitions). You can adjust the size of each partition using the slide bar between the partitions in the **Volume Scheme:** area.
7. In the **Volume Information** section, enter a name for each volume (partition), choose the volume format.
8. Once you have finalized the volume options, click **Partition**. Click **Partition** again when the alert message appears to continue.
9. Mac Disk Utility will format and partition the disk according to your settings, and your drive will be ready to use.



IMPORTANT INFO: Please refer to section 3.4.1. *File System Formats*, for a more detailed comparison of the various file system formats.



IMPORTANT INFO: Apple recommends that unless you have a specific reason to use the UNIX File System (UFS), you should use the Mac OS Extended format because it provides a more familiar experience to Macintosh users.



CAUTION: Following these steps will erase everything from the 2big. If you have information that you want to protect or continue to use, back up this information before performing these steps.



IMPORTANT INFO: If 2big Quadra is in Mixed mode, each partition will have to be initialized separately.

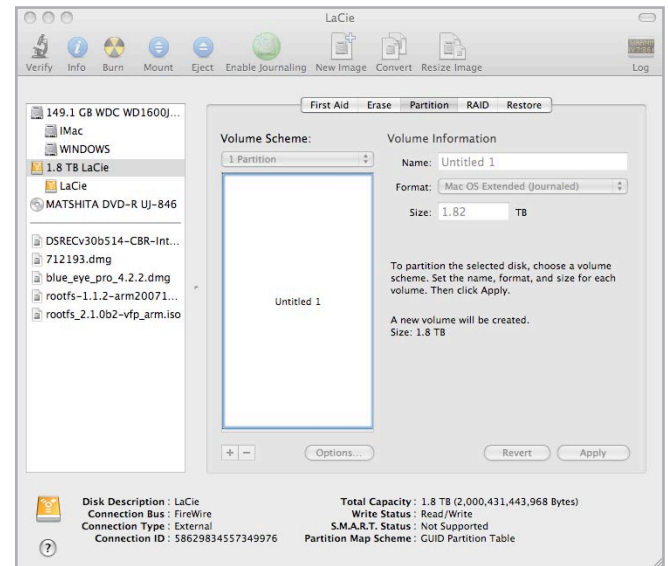

Figure 3.4.3

3.5. Partitioning the Disks

You must partition the drives after changing the 2big configuration mode (SAFE, FAST, BIG, etc). During this process, you will format the drives. For more information about file system formats, see section 3.4.1. *File System Formats*.

IMPORTANT INFO: The disks shipped with the 2big Quadra are formatted HFS+. To use the drives with Mac operating systems or for cross-platform use between Mac and PC, the drives must be reformatted. For more information, see section 3.4.1. *File System Formats*.

CAUTION: If the 2big is in Mixed mode, the disk is already partitioned. LaCie recommends NOT to partition the disk, but it is possible to partition or format each existing partition separately if necessary.

3.5.1. Windows Users

This example illustrates the Fast storage policy, which optimizes the LaCie 2big for performance.

1. Right click the **My Computer** icon on your desktop and select **Manage** from the pop-up window (Fig. 3.5.1-A).
2. Select **Disk Management** under **Storage** to open the **Windows Disk Manager** (Fig. 3.5.1-B).

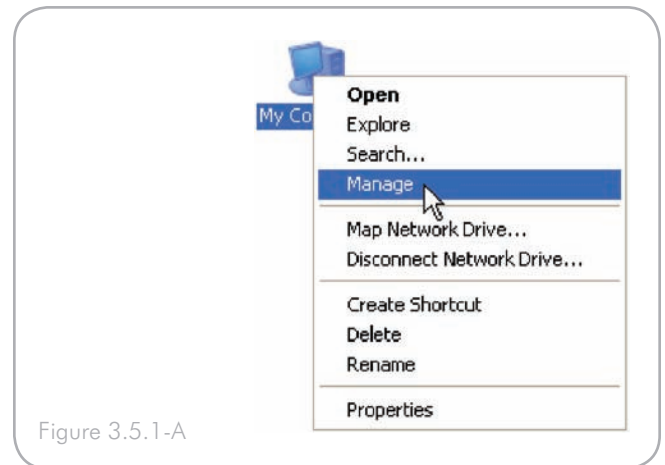

Figure 3.5.1-A

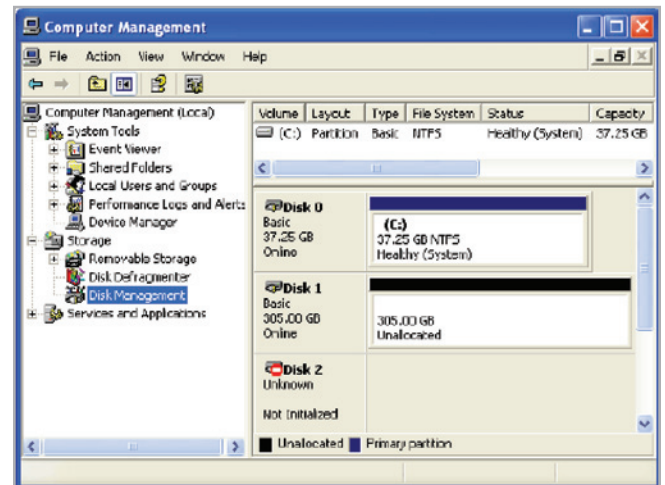

Figure 3.5.1-B

3. Right click the configured disk's unallocated space and select **New Partition**. If the New Partition option is not available, select the disk and initialize it first (Fig. 3.5.1-C).

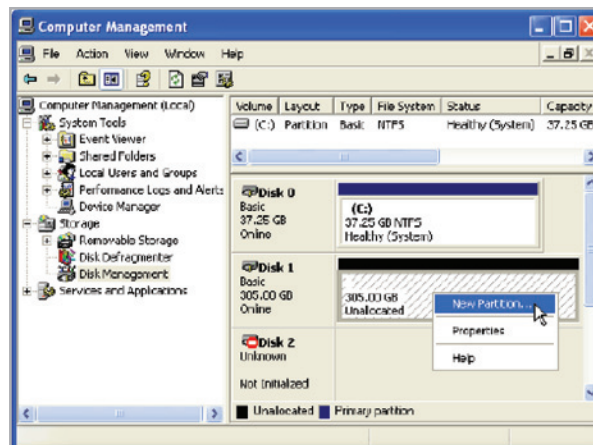

Figure 3.5.1-A

4. Click **Next** to start the Partition Wizard (Fig. 3.5.1-D).

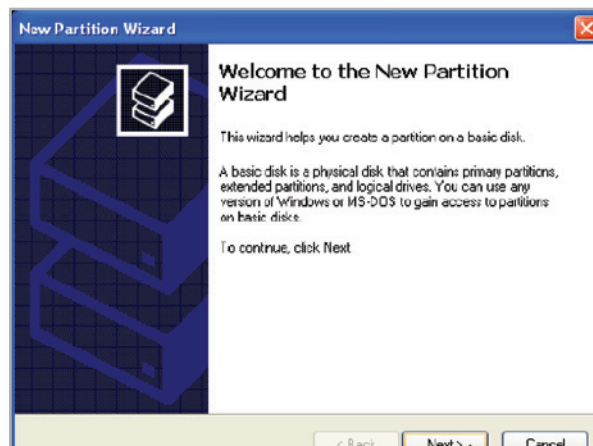

Fig. 3.5.1-D

5. Select the **Primary** or **Extended** option and click **Next** (Fig. 3.5.1-E).

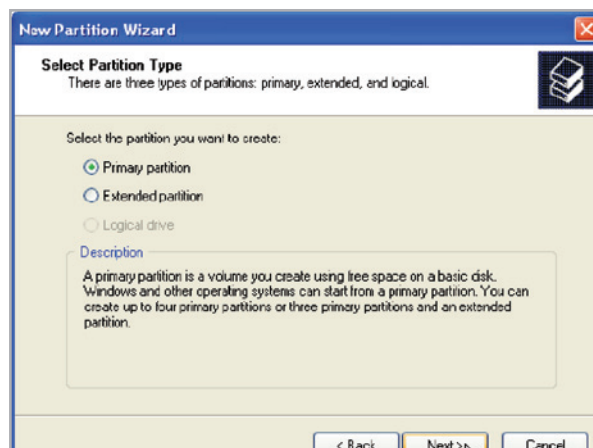

Fig. 3.5.1-E

- Specify the partition size. By default, the partition occupies the entire volume. Click **Next** (Fig. 3.5.1-F).

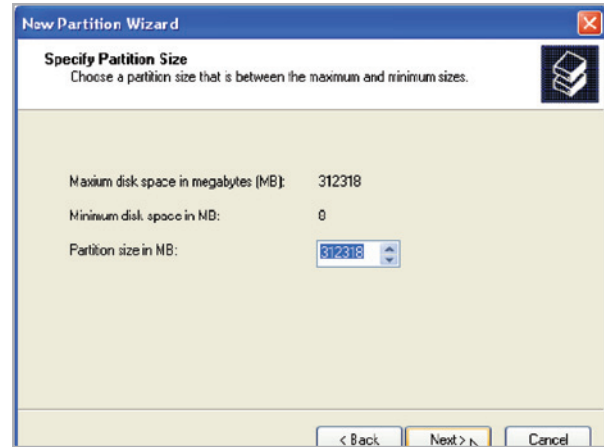

Fig. 3.5.1-F

- Assign a drive letter or mount path and click **Next** (Fig. 3.5.1-G).

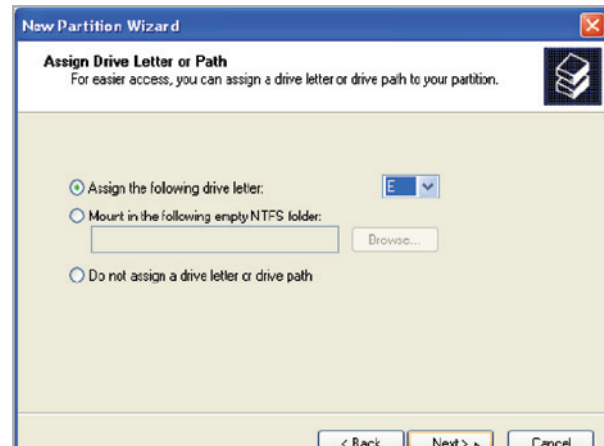

Fig. 3.5.1-G

- Name and format the partition and click **Next** (Fig. 3.5.1-H).

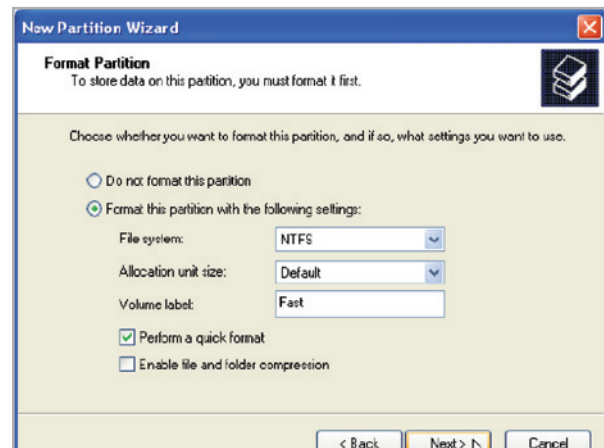

Fig. 3.5.1-H

9. Review the settings and click **Finish** to create the logical partition (Fig. 3.5.1-1).

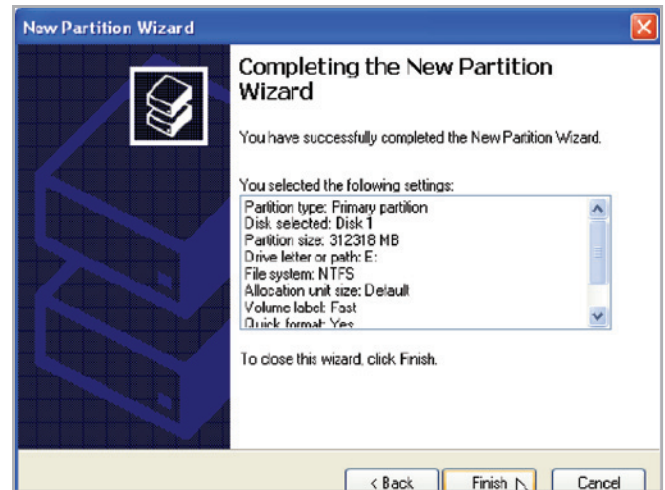

Fig. 3.5.1-1

3.5.2. Mac Users

CAUTION: Following these steps will erase everything from the hard disk. If you have information that you want to protect or continue to use, back up this information before performing these steps.

CAUTION: If the 2big is in Mixed mode, the disk is already partitioned. LaCie recommends NOT to partition the disk, but it is possible to partition or initialize each existing partition separately if necessary.

1. Select **Utilities** from the Go menu in Finder.
2. Open Disk Utility.
3. In the disk list on the left side of the Disk Utility window, find the disk corresponding to your LaCie hard disk. For each disk there is a listing for the drive controller and one for each volume on the disk. Select the listing for the controller (ex. "1.8 TB LaCie" in Fig. 3.5.2-A).
4. Select the **Partition** tab.
5. From the **Volume Scheme** menu, choose the number of partitions you want to divide the drive into (16 maximum). You can adjust the size of each partition using the slide bar between the partitions in the **Volume Scheme** area.
6. In the **Volume Information** section, enter a name for each volume (partition) and choose the volume format (Mac OS Extended, Mac OS Standard, UNIX File System, or MS-DOS).

TECHNICAL NOTE: To share a volume with Windows users, select MS-DOS (FAT32) format.

IMPORTANT INFO: Apple recommends that unless you have a specific reason to use the UNIX File System (UFS), you should use the Mac OS Extended format because it provides a more familiar experience to Macintosh users.

8. Click **Partition**. Click **Partition** again to close the alert message and continue.
9. Mac Disk Utility will format and partition the disk according to your settings, and your drive will be ready to use.

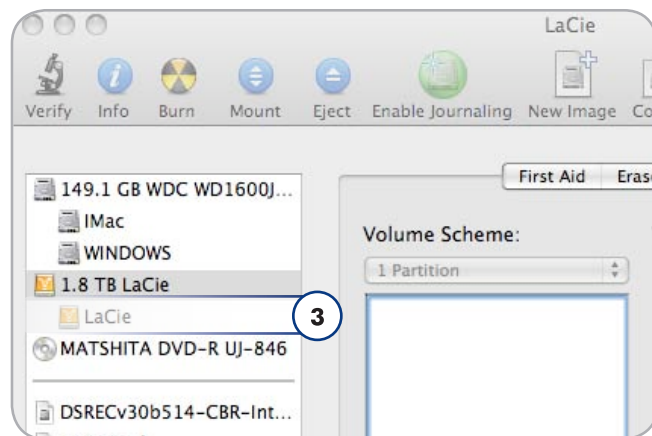

Figure 3.5.2-A

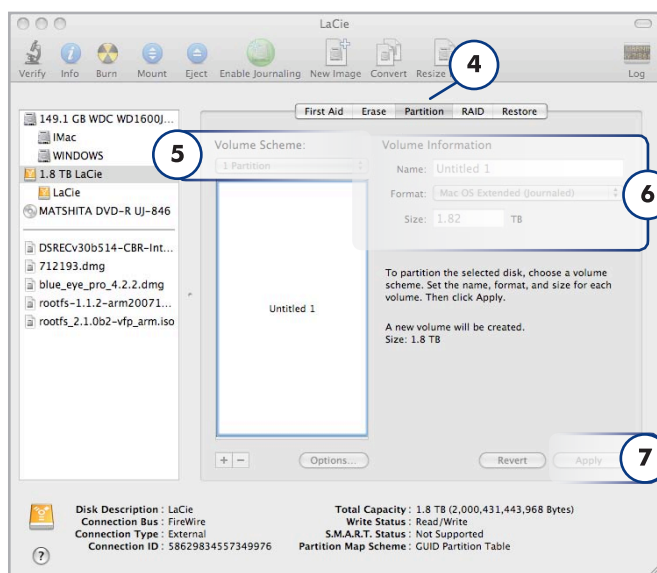

Figure 3.5.2-B

4. Troubleshooting

In the event that your LaCie 2big is not working correctly, please refer to the following checklist to find out where the problem is coming from. If you have gone through all of the points on the checklist and your drive is still not working correctly, please have a look at the FAQs that are regularly published on our Web site – www.lacie.com. One of these FAQs may provide an answer to your specific question. You can also visit the drivers pages, where the most recent software updates will be available.

If you need further assistance, please contact your LaCie reseller or LaCie Technical Support (see section 5. [Contacting Customer Support](#) for details).

Manual Updates

LaCie is constantly striving to give you the most up-to-date, comprehensive user manuals available on the market.

It is our goal to provide you with a friendly, easy-to-use format that will help you quickly install and utilize the many functions of your new device. If your manual does not reflect the configurations of the product that you purchased, please check our Web site for the most current version available.

www.lacie.com

4.1. LED Status Indicators

Use the 2big's front and rear LEDs and the chart below as a reference to determine the status of your 2big:

If the front LED is:	And the rear LED is:	And the RAID mode is:	Then:
Solid blue 	Blinking blue 	All	The 2big is working properly, only active disks' LEDs blink.
Blinking blue 	Blinking blue 	All	The 2big is starting up; front LED and LEDs of functional disks become solid blue when initialized.
Dimming blue (5s)* 	Off	All	The 2big is in standby mode. If the power switch is set to "auto" the 2big will enter standby when your computer is either off or in standby. If rebuilding has begun, the process will finish before the 2big can enter standby. After 30 minutes of standby, the LED will switch off.
Alternating long blue and short red: 	One disk is blinking blue, while the other disk is blinking 3 blue, 1 red: 	Safe	RAID is rebuilding.
		Mixed	
	Solid red (failed disks) and solid blue (functional disks)	Safe	One drive has failed or was improperly inserted; RAID is functional but the security of the drives has been compromised.
		Mixed	
Solid red 	Solid red (failed disks) and solid blue (functional disks)	All	One or more drives have failed or are improperly inserted; RAID is not functional.
Blinking blue/red 	Normal LED activity	All	Temperature alert; allow the 2big to finish current processes and then shut it down. Make sure the ventilation holes on the back of the 2big are not obstructed and that there is ample room for airflow around the unit. Allow the 2big to cool before turning it back on.
Dimming red (5s)* 	Off	All	During standby mode, when one or more drives have failed or are improperly inserted; RAID is not functional. Dimmed LED stays on for 30 minutes.

continued on the next page

* LED dims for 5 seconds and then remains at a low intensity.

If the front LED is:	And the rear LED is:	And the RAID mode is:	Then:
Dimming red (5s)* 	Off	All	Temperature critical; LaCie recommends that following this event you leave the 2big in standby for at least an hour before restarting to prevent damage to the disks.
Off	Off	All	The 2big is either turned off, or has been in standby mode for more than 30 minutes, or system or electronic board failure; in this case, contact LaCie customer support.

* LED dims for 5 seconds and then remains at a low intensity.

4.2. Other Troubleshooting Topics

Problem	Solutions
The 2big is not recognized by the computer.	<p>If there is no icon for the 2big on the desktop (Mac users) or in My Computer (Windows users):</p> <ul style="list-style-type: none">◆ Check the interface cable connection. Check both ends of the FireWire, eSATA or USB cables and make sure that they are fully seated in their respective ports. Try disconnecting the cables, waiting 10 seconds, and then reconnecting them. If the drive is still not recognized, restart your computer and try again.◆ Make sure your computer meets the minimum system requirements for compatibility with the 2big Quadra. See section 1.1. Minimum System Requirements for more information.◆ Make sure the power supply is properly connected (see section 2.2. Turn the Drive On), that the drive has been turned on by pressing the On/Off/Auto button the back of the drive, and that the outlet the power supply is connected to is also turned on.◆ Make sure that the drive has been formatted properly. Please see section 3.5. Partitioning the Disks.
The 2big is working slowly.	<p>If other USB, eSATA or FireWire devices are connected to the same port or hub, disconnect the other devices and see if the 2big's performance improves.</p>
Power supply failure.	<p>Replacement power supplies can be purchased from LaCie at: www.lacie.com</p>

5. Contacting Customer Support

Before You Contact Technical Support

1. Read the manuals and review section 4. *Troubleshooting*.
2. Try to isolate the problem. If possible, make the drive the only external device on the CPU, and make sure that all of the cables are correctly and firmly attached.

If you have asked yourself all of the pertinent questions in the troubleshooting checklist, and you still can't get your LaCie drive to work properly, contact us at www.lacie.com. Before contacting us, make sure that you are in front of your computer and that you have the following information on hand:

Information	Where to Find Information
1. LaCie hard drive serial number	Located on a sticker at the back of drive or on the original packaging
3. Macintosh/PC model	Mac users: Click on the Apple icon in the menu bar and select About This Mac . Windows users: Right click My Computer and select Properties > General .
4. Operating system version	
5. Processor speed	
6. Computer memory	
7. The brands and models of other internal and external peripherals installed on your computer	Mac users: Click on the Apple icon in the finder bar and select About This Mac . Select More Info... The Apple System Profiler will launch and will list your internal and external peripherals. Windows users: Right click My Computer and select Properties > Hardware .

5.1. LaCie Technical Support Contacts

LaCie Asia, Singapore, and Hong Kong Contact us at: http://www.lacie.com/asia/contact/	LaCie Australia Contact us at: http://www.lacie.com/au/contact/
LaCie Belgium Contact us at: http://www.lacie.com/be/contact/ (Français)	LaCie Canada Contact us at: http://www.lacie.com/caen/contact/ (English)
LaCie Denmark Contact us at: http://www.lacie.com/dk/contact	LaCie Finland Contact us at: http://www.lacie.com/fi/contact/
LaCie France Contact us at: http://www.lacie.com/fr/contact/	LaCie Germany Contact us at: http://www.lacie.com/de/contact/
LaCie Italy Contact us at: http://www.lacie.com/it/contact/	LaCie Japan Contact us at: http://www.lacie.com/jp/contact/
LaCie Netherlands Contact us at: http://www.lacie.com/nl/contact/	LaCie Norway Contact us at: http://www.lacie.com/no/contact/
LaCie Spain Contact us at: http://www.lacie.com/es/contact/	LaCie Sweden Contact us at: http://www.lacie.com/se/contact
LaCie Switzerland Contact us at: http://www.lacie.com/chfr/contact/ (Français)	LaCie United Kingdom Contact us at: http://www.lacie.com/uk/contact
LaCie Ireland Contact us at: http://www.lacie.com/ie/contact/	LaCie USA Contact us at: http://www.lacie.com/contact/
LaCie International Contact us at: http://www.lacie.com/intl/contact/	

6. Warranty Information

LaCie warrants your LaCie 2big against any defect in material and workmanship, under normal use, for the period designated on your warranty certificate. In the event this product is found to be defective within the warranty period, LaCie will, at its option, repair or replace the defective LaCie 2big.

In the event of a drive failure please contact your LaCie reseller or LaCie customer support for drive replacement procedure.

This warranty is void if:

- ◆ The LaCie 2big was operated/stored in abnormal use or maintenance conditions;
- ◆ The LaCie 2big is repaired, modified or altered, unless such repair, modification or alteration is expressly authorized in writing by LaCie;
- ◆ The LaCie 2big was subjected to abuse, neglect, lightning strike, electrical fault, improper packaging or accident;
- ◆ The LaCie 2big was installed improperly;
- ◆ The serial number of the LaCie 2big or an individual Drive Bay is defaced or missing;
- ◆ The broken part is a replacement part such as a pickup tray, etc.
- ◆ The tamper seal on the LaCie 2big or an individual Drive Bay casing is broken.
- ◆ One or two of the hard disks have been removed and replaced by any hard disk other than a drive provided by LaCie. For drive removal/replacement process, see section 3.3. *Removing and Installing Drives*.

LaCie and its suppliers accept no liability for any loss of data during the use of this device, or for any of the problems caused as a result.

LaCie will not, under any circumstances, be liable for direct, special or consequential damages such as, but not limited to, damage or loss of property or equipment, loss of profits or revenues, cost of replacement goods, or expense or inconvenience caused by service interruptions.

Any loss, corruption or destruction of data while using a LaCie drive is the sole responsibility of the user, and under no circumstances will LaCie be held liable for the recovery or restoration of this data.

Under no circumstances will any person be entitled to any sum greater than the purchase price paid for the drive.

To obtain warranty service, call LaCie Technical Support. You

will be asked to provide your LaCie product's serial number, and you may be asked to furnish proof of purchase to confirm that the drive is still under warranty.

All systems returned to LaCie must be securely packaged in their original box and shipped with postage prepaid.



IMPORTANT INFO: Register online for free technical support: www.lacie.com/register

Note to Australian Customers

Our goods come with guarantees that cannot be excluded under the Australian Consumer Law. You are entitled to a replacement or refund for a major failure and for compensation for any other reasonably foreseeable loss or damage. You are also entitled to have the goods repaired or replaced if the goods fail to be of acceptable quality and the failure does not amount to a major failure.

Contact us:

LaCie Australia, 458 Gardeners Road Alexandria, NSW 2015 AUSTRALIA.

Phone: 02 8063 3711

Email: info.au@lacie.com

For fast technical support, create a support ticket after registering your product at <http://www.lacie.com/au/register>.